

PRODUCT DESCRIPTION

- Line of light in a shallow profile and flat cover
- Possibility of bending the extrusion
- Wide assortment of mounting accessories

FINISH :

Silver anodized 

Fill empty fields

Product nr.	
Fixture type	
Company	
Job name	
Date	

TECHNICAL SPECIFICATION

Application

- construction of lighting fixtures for main or decorative lighting

Assembly

- suitable for mounting on flat surfaces, suspending from **DP** fasteners, for attaching to mounting systems and for fixing with mounting springs, to ARMSTRONG ceilings with the **AM-24** mounting bracket
- compatible with a group of extrusions dedicated to drywall panels. It is designed for mounting in the **TEKNIK-ZM** and **TEKUS** extrusions using **TEKNIK** clips

Number of clips:

Extrusion length	39.4"(1 m)	78.75"(2 m)
Number of TEKNIK clips	8	18

Additional information

- can be mounted in a groove made using a mounting extrusion
- guidelines for bending the GIZA-LL extrusion: minimum internal radius 30cm (light directed towards the centre of the circle), minimum external radius 19,7" (50cm) (light directed outside the circle)
- a line of light obtainable with the LIGER-22 cover and a LED strip with a minimum of 40 LEDs/foot (120 LEDs/meter)
- GIZA-LL is designed for two or one 0.39" (10 mm) wide LED strip

AVAILABLE LENGTHS

Ref. nr.	surface finish	available lengths
C0758ANODA_1	Silver anodized	39.4"
C0758ANODA_2	Silver anodized	78.75"

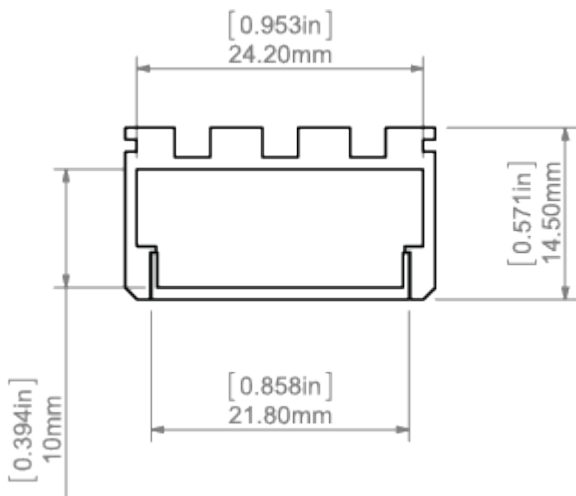
TECHNICAL DRAWING

RELATED EXTRUSIONS

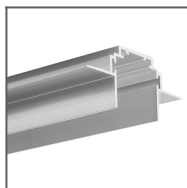

TEKNIK-ZM
Extrusion
Ref: C0399NA

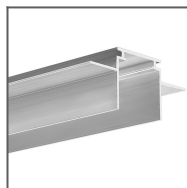

TEKUS Extrusion
Ref: B6638V1NA

RELATED PRODUCTS

COVERS

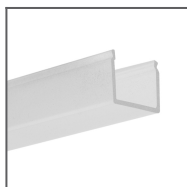

G-K Cover semi-transparent
Ref: 00415

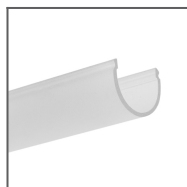

G-L Cover semi-transparent
Ref: 17008

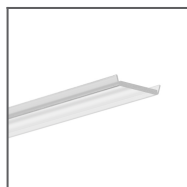

HS-22 Cover clear
Ref: 17022

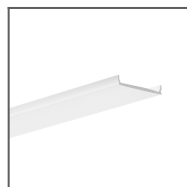

LIGER-22 Cover frosted
Ref: 17032

110°

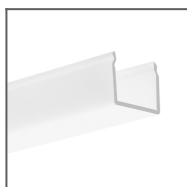

G-K Cover frosted
Ref: 17007

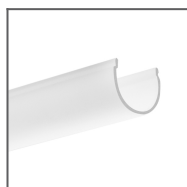

G-L Cover frosted
Ref: 00413

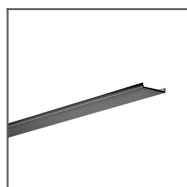

LIGER-22 black
Cover
Ref: 17044

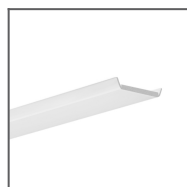

HS-22 Cover frosted
Ref: 17011

END CAPS

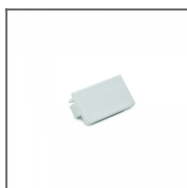

GIZA-LL End cap
Ref: 24281

ACCESSORIES

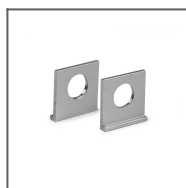

ZM EYE UCHO
Hanger
Ref: 42512



BZP Head
Ref: 42213



BZP-ZZ Head
conductive
Ref: 42215



TEKNIK Clip
Ref: 24003



PUSZ-LIN-ZM
Fastener
Ref: 42256



PUSZ-PRET-ZM
Fastener
Ref: 42250

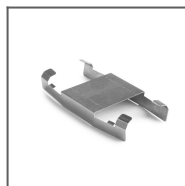

AM-24 Mounting
bracket
Ref: 24235



GIP Mounting
bracket
Ref: 24143



REGIP-UV
Adjustable
Mounting bracket
Ref: 24271



DP-ZZ Fastener
Ref: 00651

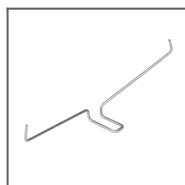

GP Spring
Ref: 00293

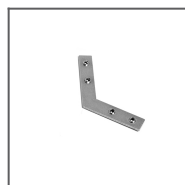

ZM-120
Connector
Ref: 42728

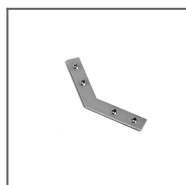

ZM-135
Connector
Ref: 42720

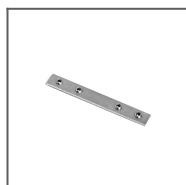

ZM-180
Connector
Ref: 42717

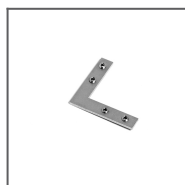

ZM-90 Connector
Ref: 42716

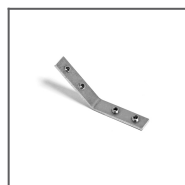

ZM-PION-135
Connector
Ref: 42719

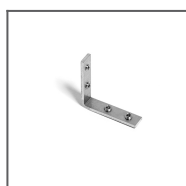

ZM-PION-90
Connector
Ref: 42718



8,8x1,2 Gland
Ref: 00802

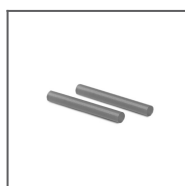

ZM Block
Ref: 42520