

PRODUCT DESCRIPTION

SEPOD – a basic extrusion used to build suspended or surface mounted fixtures.

Patent Number: US D775,409 S

- High luminous efficiency
- Ability to create a line of light
- Easy mounting with numerous methods
- Can be combined into straight and broken linear runs

FINISH :

Silver anodized

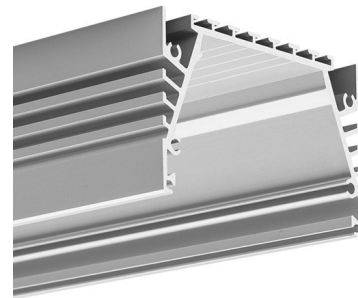

Fill empty fields

Product nr.	
Fixture type	
Company	
Job name	
Date	

TECHNICAL SPECIFICATION

Application

- high performance, main lighting installation
- construction of surface mount or suspended lighting fixtures as main and work lighting (corridors, halls, workshops, ballrooms, etc.)

Assembly

- o build suspended fixtures you can use DP fasteners, drywall fasteners or ready-made KLUŚ fastening kits. To surface mount the SEPOD extrusion you can use GP surface springs, KMA groove springs or the TESPO mounting track

Additional information

- can be fitted with several different types of covers

Turn off LED lights during peak day light hours in outdoor applications to avoid excessive heat buildup which will result in diminished LED life.

TECHNICAL DRAWING

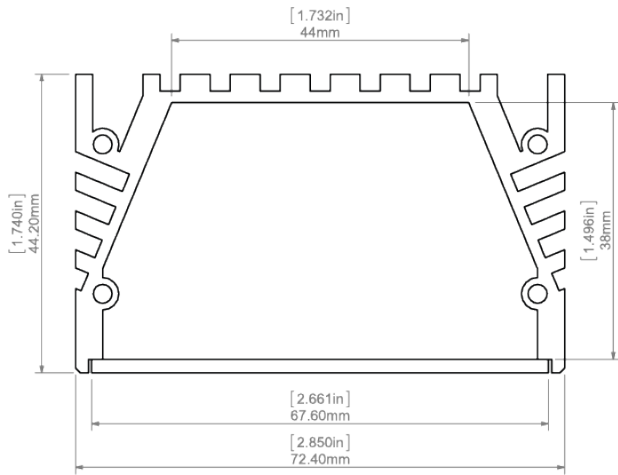

RELATED EXTRUSIONS

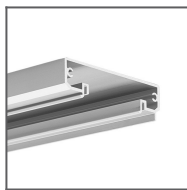

TESPO Mounting Track
Ref: 18020ANODA

RELATED PRODUCTS

COVERS

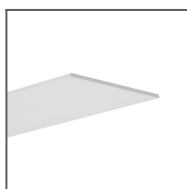

SZER Cover clear
Ref: 17082

80°

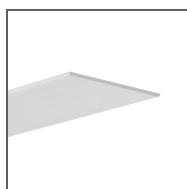

SZER Cover
Ref: 17081

80°

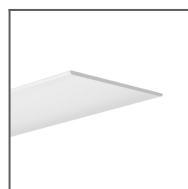

SZER-L Cover frosted
Ref: 17083

110°



END CAPS

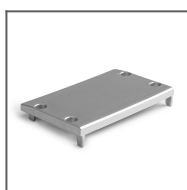

SEPOD-MET End cap
Ref: 24106

ACCESSORIES

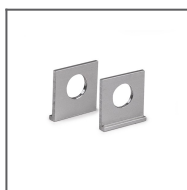

ZM EYE UCHO Hanger
Ref: 42512

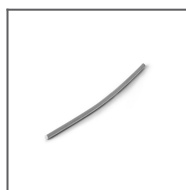

BLOK Spring
Ref: 42731V1

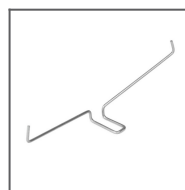

GP Spring
Ref: 00293

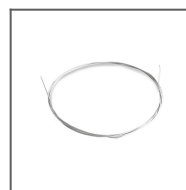

Stainless Steel Wire 39.4"
Ref: 70240



PUSZ-LIN-ZM
Fastener
Ref: 42256



PUSZ-PRET-ZM
Fastener
Ref: 42250

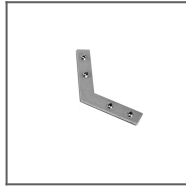

ZM-120
Connector
Ref: 42728

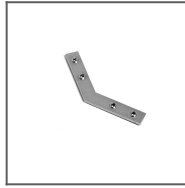

ZM-135
Connector
Ref: 42720



ZM-180
Connector
Ref: 42717

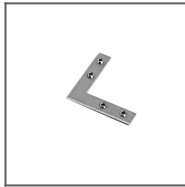

ZM-90 Connector
Ref: 42716

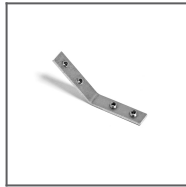

ZM-PION-135
Connector
Ref: 42719

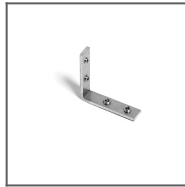

ZM-PION-90
Connector
Ref: 42718



Rubber Grommet
Ref: 42264

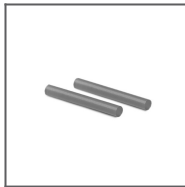

ZM Block
Ref: 42520